

Wireless Presenter User Manual

N95/N95 Plus

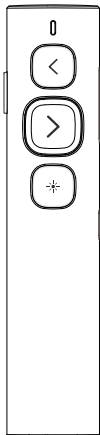

Be sure to read this user manual carefully before using the wireless presenter and keep it for future reference.

WARNING

This product can generate laser beam. DO NOT STARE INTO BEAM OR EXPOSE USERS OF TELESCOPIC OPTICS. Do not shine the laser beam on people's or animal's eyes to avoid eye damage! Do not give this product to children as a toy!

Warning label for red laser product:



Warning label for green laser product:



I. Safety Precautions

1. Use this product correctly according to this manual.
2. This product is for professional use only. Children under 14 years of age are strictly prohibited from using it.
3. Do not point the laser beam at human eyes, including via mirror reflections.
4. Do not observe the laser beam with naked eyes or using optical instruments (e.g., telescopes or magnifying glasses).
5. Avoid pointing the laser beam arbitrarily at various optical reflective surfaces.
6. Do not intentionally or casually irradiate people.
7. This product contains a built-in lithium battery. If the battery swells, stop using it.
8. Do not place the product in high-temperature environments or throw it into fire.
9. Do not immerse this product in

water or any other liquid.

10. Do not disassemble, impact, or crush the product without authorization. If the product malfunctions, contact Norwii after-sales support.

II. Operation system

Supports Windows 10/11 and macOS 10.15 and later. On Android and Linux systems, only support laser and page up/down functions.

III. Package contents

1. Wireless presenter * 1 (USB receiver stored inside the wireless presenter)
2. User Manual * 1

IV. Function map

N95

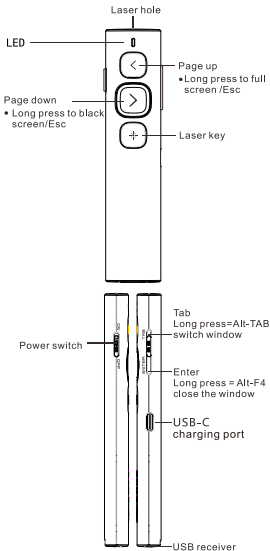

The Professional Presenter

N95 Plus

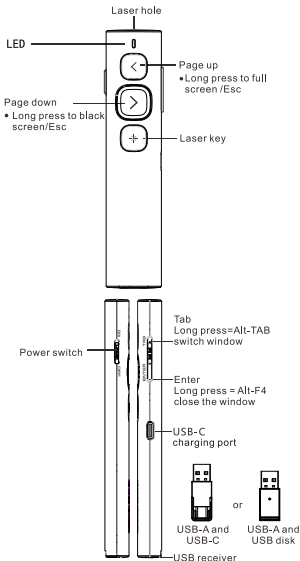

Attention: When using this product, please change your Input Method Editors (IME) to English input mode.

V. Specifications

Transmitter

Technology: Radio frequency

Frequency: 2.4GHz

Control Distance: 100m

Laser Power: see warning label on the product

Laser Distance: >200m

Wavelength: Red 640-660nm

Wavelength: Green 495-545nm

Battery capacity: 300mAh lithium battery

Working Voltage: 3.6-4.2V

Charging Voltage: 5V

Dimension: 131*29.6*13.2mm

Weight: 34.5g

USB-A receiver

Working Voltage: 4.5-5.5V

Dimension: 34.8*14*7.9mm

Weight: 3.2g

USB-A and USB-C receiver

Working Voltage: 4.5-5.5V

Dimension: 40*14*6.4mm

Weight: 3.7g

USB-A and U-disk receiver

Working Voltage: 4.5-5.5V

Dimension: 34.8*14*8mm

Weight: 3.2g

VI. Function Description

1. Power switch: push up to "ON" to turn on the presenter, push down to "OFF" to turn off the presenter.

2. Page up key : click to page up, long press to play slides from the current page. Long press again to end slide show.



3. Page down key : click to page down, long press to enter black screen, long press again to exit black screen.

4. Physical laser key : Press and hold to turn on the physical laser beam, and release to turn off the physical laser beam.

5. Hyperlink operation: Press the "Tab" key to switch between hyperlinks on the page, and press the "Enter" key to open the hyperlink. Long press the 'Enter'

key to execute Alt-F4 to close the current active window. When switching windows, press and hold the "Tab" key to execute the Alt Tab function to switch between open windows. Release the button on the window that needs to be switched to switch to the desired window.

6. Function switching of the page up and down keys.

Long press  and  simultaneously to switch between the four modes.

1) By default, the page up and down keys on the Bluetooth wireless presenter correspond to the left and right arrow keys on the computer keyboard, which is suitable for PowerPoint, WPS, Prezi, and Keynote.



2) The first time you press and hold both the page up and down keys on the wireless presenter simultaneously, the function will switch to the Page Up and Page

Down keys on the computer keyboard. This is suitable for image-viewing software.

An orange rounded square button with the text "PgUp" in white.An orange rounded square button with the text "PgDn" in white.

3) The second time you press and hold both the page up and down keys simultaneously, the function will switch to the mouse scroll wheel function. This is suitable for some short-video apps and web browsers.



4) The third time you press and hold both the page up and down keys simultaneously, the function will switch to the up and down arrow keys on the computer keyboard. This is suitable for Word, Excel, and other applications.



5) The fourth time you press and hold both the page up and down

keys simultaneously, the function will switch to the default left and right arrow keys on the computer keyboard.



6) After switching the function, it will be automatically saved. When you restart the wireless presenter, you can continue to use the switched function.

7. The page up/down keys can be customized by Norwii Presenter software.

VII. Installation

1. Take out the USB receiver and install.

Remove the USB receiver from the lower part of the wireless presenter, and then plug it into the USB interface of the computer. At this time, the bottom right corner of the computer desktop will display "Discovered New Hardware", and the system will automatically install

The Professional Presenter

the driver. When Windows displays "New hardware installed and ready to use", it indicates that the USB receiver installation is complete. The attached image is as follows:

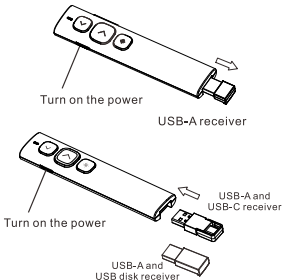

(Take out the USB receiver)

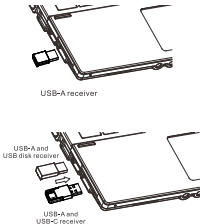

the USB receivers

2. Control the wireless presenter by operating the key of the flip pen.

3. Turn off the wireless presenter.

After use, please return the USB receiver to the presenter's original position and turn off the power switch to further save power. The attached image is as follows:

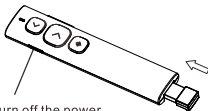

Turn off the power

USB-A receiver

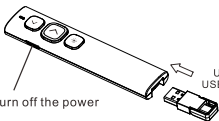

Turn off the power

USB-A and
USB-C receiver

USB-A and
USB disk receiver

VIII. Wireless presenter charging

1. Low power indication.

The blue LED on the wireless presenter will flash slowly to remind the user to charge the presenter.

2. Charging the wireless presenter.

Connect one end of the USB cable to the computer USB interface and the other end to the USB-C interface of the wireless presenter.

When the wireless presenter charges, the red indicator light always lights up. When the red indicator light turns green, it indicates that the wireless presenter is fully charged. If you have a USB-C interface handheld charger, it can also be used to charge the wireless presenter.

3. Charging time

The charging time varies depending on the power supply of the USB interface. Normally, charging can be completed after about 2 hours of charging.

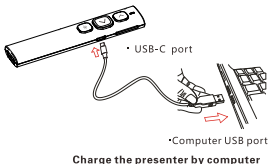

IX. Frequently Asked Questions

1. How to download Norwii Presenter software and how to pair the presenter and the USB receiver?

For products that support key function customization or highlight serial products that support digital laser, highlight, magnifier, you need to download Norwii Presenter software. Please download it from the "Downloads" under the "Support" menu of Norwii official website www.norwii.com in English version.

2. How to know if the battery is out of power?

Turn on the power of the presenter,

then press laser key to check if the laser can be turned on. If the laser cannot be turned on, usually it means the battery is out of power or the laser diode is dead and needs replacement.

If other buttons are pressed and the LED indicator light does not indicate, it also indicates that the battery is out of charge. Please charge it in a timely manner.

When the battery level is low, the indicator light on the wireless presenter will enter a slow flashing state, reminding the user to charge in a timely manner.

3. Why does the laser pointer not work?

The laser does not light up, please check:

- 1) Is the power switch turned on? If not, turn on the power.
- 2) check whether the wireless presenter is in low power or out of power. If the LED flashes slowly, it means the power is low and the

battery needs to be charged.

3) If other functions of the wireless presenter are normal and only the laser is not on, it indicates that the laser module is broken and needs replacement.

4. What to do if the laser becomes dim?

Laser dimming is generally due to low battery power and the need for timely charging. If the laser beam remains only a red dark spot after being fully charged, it indicates that the laser module is aging. When the laser module ages, please contact us for after-sales repair.

5. Why does the computer do not detect the device when the USB receiver plugs into the PC?

Please check whether the USB works or not. You can use a USB mouse or keyboard to test the USB port. If a USB mouse or keyboard works on the USB port and the USB receiver of the presenter doesn't work, it means the USB receiver is

broken or the USB drivers is not compatible with the USB receiver.

You can try another USB port of the same computer or USB ports of another computer to check whether the USB receiver is good or not. If it works on other computer, it means the USB drivers of the computer are not compatible with the USB receiver. You need to back up your data and reinstall the OS.

6. Special tips for charging.

The product only supports standard 5V charging and does not support all kinds of QC quick charging. Charging with a voltage higher than 5V will burn the product or fail to charge.

7. The laser is ok, and the USB receiver can be detected by the computer, why does the presenter control the computer?

The reason is the USB receiver doesn't save the presenter's address properly. You can use Norwii Presenter software to let the

USB receiver to save the presenter's address again. We also call this operation is to PAIR the wireless presenter and the USB receiver.

8. How to adjust the settings for Norwii Presenter on macOS?

On Apple's macOS, the Norwii Presenter software requires three permissions: Accessibility, input monitoring, Screen & System Audio Recording. If it has not been set before, please click "Grant Permissions" in the "About" tab of the Norwii Presenter software, and then open the corresponding permission settings in the window that opens. You can also check the box in front of the Norwii Presenter software in the above three permission settings in the "Launchpad - System settings – Privacy & Security – Accessibility, input monitoring, Screen & System Audio Recording" of macOS.

9. In practice, some users have experienced the issue where PowerPoint and Keynote fail to turn pages in full-screen mode after enabling Full Keyboard Access.

On Apple's iOS and iPadOS, when PowerPoint and Keynote are in full-screen mode, pressing the page up and page down keys on a wireless presenter does not turn the pages. Instead, the cursor focus moves between text areas. Please disable ****Settings -> Accessibility -> Full Keyboard Access****.

X. FCC Statement

Any Changes or modifications not expressly approved by the party responsible for compliance could void the user's authority to operate the equipment.

This device complies with part 15 of the FCC Rules. Operation is subject to the following two conditions:

1. This device may not cause

harmful interference, and

2. This device must accept any interference received, including interference that may cause undesired operation.

XI. FCC Radiation Exposure Statement

1. This equipment complies with FCC radiation exposure limits set forth for an uncontrolled environment. This equipment should be installed and operated with minimum distance 20cm between the radiator& your body.

2. Note: This equipment has been tested and found to comply with the limits for a Class B digital device, pursuant to part 15 of the FCC Rules. These limits are designed to provide reasonable protection against harmful interference in a residential installation. This equipment generates, uses and can radiate radio frequency energy and, if not installed and used in

accordance with the instructions, may cause harmful interference to radio communications. However, there is no guarantee that interference will not occur in a particular installation. If this equipment does cause harmful interference to radio or television reception, which can be determined by turning the equipment off and on, the user is encouraged to try to correct the interference by one or more of the following measures:

- Reorient or relocate the receiving antenna.
- Increase the separation between the equipment and receiver.
- Connect the equipment into an outlet on a circuit different from that to which the receiver is connected.
- Consult the dealer or an experienced radio/TV technician for help.

XII. Certifications

CE, ROHS, FDA

FCCID: 2AXGRN95

XIII. Declaration of conformity

This laser product complies with EN 50689:2021 and IEC/EN60825-1:2014/A11:2021. Complies with 21 CFR 1040.10 and 1040.11, except for deviations pursuant to Laser Notice No.50, dated June 24, 2007.

Shanghai Norwii Technology Co.,
Ltd.

Add: 2F, Building 3, No 277, Jinfeng
Road, Pudong New Area, Shanghai
201201, P. R. China

Tel: 86-21-51872080

Email: support@norwii.com